

C P 7 -6

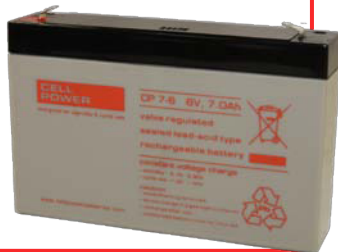

Battery for multi purpose use

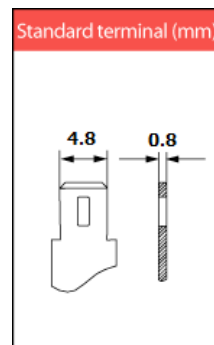
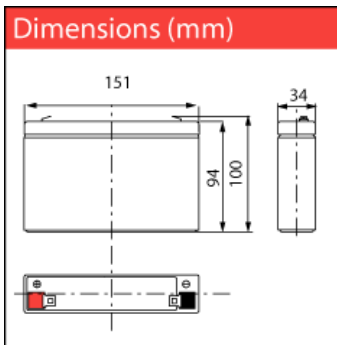

Nominal voltage	6 V DC	
Nominal Capacity (20HR, 20°C):	7 Ah	
Internal resistance	Approx. 15 m Ω	
Maximum charging current	2.1 A	
Maximum discharge current	105 A (5 sec.)	
Operating temperature range	-20°C 50°C	
Float use/ cycle use	6.8 – 6.9V/ 7.25 – 7.45V	
Expected life (20°C)	3 – 5 years in float charge	
Standard terminal	Faston 4.8 mm	
Housing material	ABS	
Dimensions	length	151 mm
	width	34 mm
	height	100 mm (±1 mm)
Approx. Weight	1.12 kg	
Packing	10 pcs/box	

Typical applications:

- Alarm devices
- Measuring equipment
- Emergency lighting
- Medical equipment
- Telecommunication systems
- UPS systems
- Toys
- Domestic applications.

- Valve Regulated Maintenance Free
- High current drain grid being resistant to corrosion by virtue of a lead-calcium alloy
- Absorbent Glassmat Technology (AGM)
- Classified as non- spillable and Non Dangerous goods by IATA, FAA, ADR, IMDG
- Can be discharged or stored in any position without leakage
- Cannot be charged while the terminal is downward

Constant Current Discharge Characteristics (A, 20°C)									
F.V/TIME	5min	10min	15min	30min	60min	3h	5h	10h	20h
4.80V	27.0	18.0	14.0	8.40	4.70	1.73	1.15	0.71	0.37
5.10V	25.7	17.1	13.4	8.06	4.55	1.70	1.13	0.70	0.36
5.40V	24.2	16.1	12.7	7.66	4.35	1.65	1.10	0.68	0.35

Constant Power Discharge Characteristics (Watt, 20°C)									
F.V/TIME	5min	10min	15min	30min	60min	3h	5h	10h	20h
4.80V	151	102	80.0	47.1	27.2	10.3	6.87	4.26	2.20
5.10V	144	95.5	76.5	45.2	26.4	10.1	6.75	4.20	2.16
5.40V	135	90.0	72.5	43.0	25.2	9.8	6.57	4.08	2.10

Charging characteristics

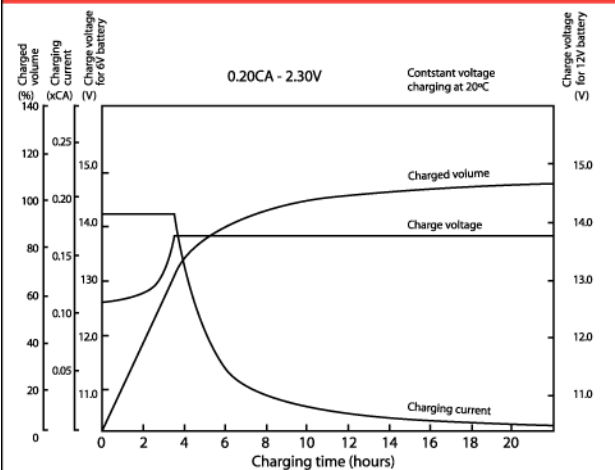

Discharge characteristics curves

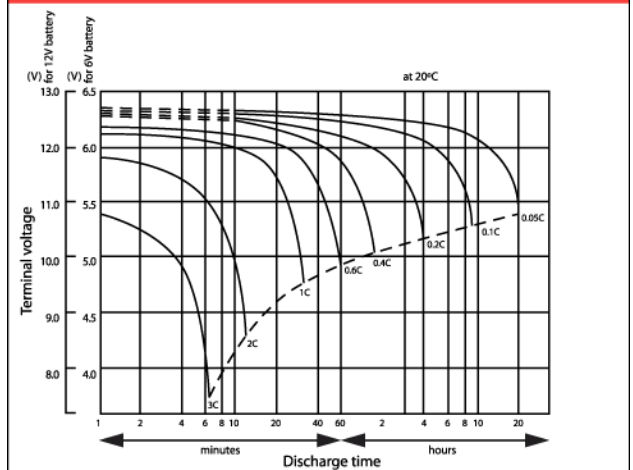

Relationship between charging voltage and temperature

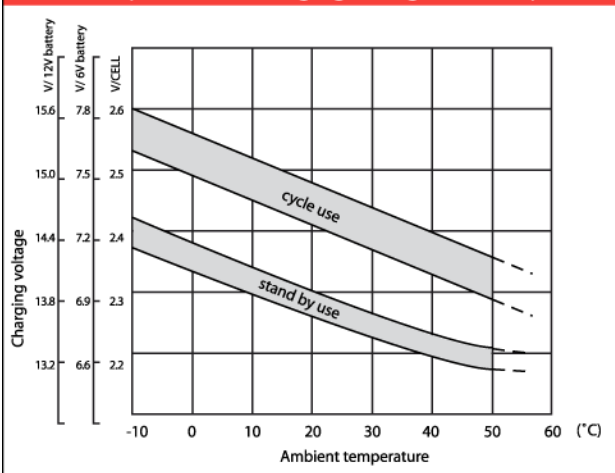

Cycle service life in relation to depth and discharge

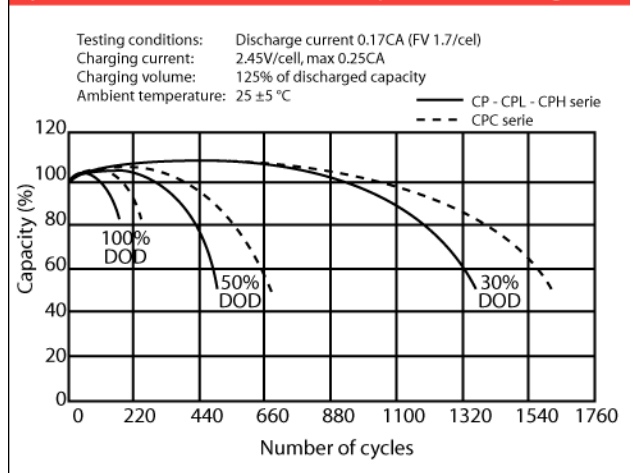

Models available

Model	Capacity (Ah)	Dimensions (mm)	Weight
CP 1.2 - 6	1.2	97 x 24 x 58	0.30 kg
CP 3.2 - 6	3.2	134 x 34 x 66	0.67 kg
CP 3.5 - 6	3.5	194 x 25 x 56	0.58 kg
CP 4 - 6	4	70 x 47 x 107	0.85 kg
CP 7 - 6	7	151 x 34 x 100	1.12 kg
CP 12 - 6	12	151 x 50 x 100	1.92 kg
CP 12 - 6L	12	151 x 50 x 100	1.92 kg
CP 0.8 - 12	0.8	96 x 25 x 62	0.36 kg
CP 1.2 - 12	1.2	97 x 43 x 58	0.58 kg
CP 2 - 12M	2	150 x 20 x 90	0.68 kg
CP 2.2 - 12	2.2	178 x 34 x 67	1.10 kg
CP 2.3 - 12C	2.3	182 x 24 x 62	0.76 kg
CP 2.9 - 12	2.9	79 x 56 x 105	1.08 kg
CP 3.2 - 12	3.2	134 x 67 x 67	1.32 kg
CP 4.5 - 12	4.5	195 x 47 x 74	1.60 kg
CP 5 - 12	5	90 x 70 x 107	1.98 kg
CP 7 - 12	7	151 x 65 x 97.5	2.40 kg
CP 7 - 12 L	7	151 x 65 x 97.5	2.40 kg
CP 12 - 12	12	151 x 98 x 101	4.10 kg
CP 18 - 12I	18	181 x 77 x 167	6.30 kg
CP 20 - 12B	20	181 x 77 x 167	6.10 kg
CP 26 - 12I	26	166 x 175 x 125	9.30 kg
CP 40 - 12I	40	197 x 165 x 170	13.10 kg
CP 65 - 12I	65	348 x 167 x 178	22.00 kg

VdS approved VRLA batteries:

The VdS-approved Cellpower batteries form a special range that has been tested and qualified by the German VdS institute. The concept behind VdS recognition; ensuring tested and certified quality in the products and services being offered in the safety and security markets, is of equally advantageous for user and supplier.

Safety and security systems are approved by the VdS and monitored in subsequent use to protect property and life and help to keep a insurance premiums lower.

Apart from the VdS approval, this range is also approved by the Dutch NCP institute, further underlining the high quality of this range.

Typical applications:

- VdS & NCP approved alarm systems
- Fire & burglar alarm systems